

ST 050 304 5360



- shower with fixed riser projection 420mm
- rain shower Ø 200 mm
- rain shower with anti-scale system
- max. rainshower flow 6.8 l/min
- rotary diverter for fixed-riser shower/hand shower
- height of fittings up to rain shower (bottom edge) 985mm
- height of fittings up to top edge of elbow 1160mm
- two-part push-on rosette Ø 65 mm
- rosette for shower holder Ø 65mm
- rosette for wall mounting Ø 60mm
- gauge 150 mm - 13 mm
- metal shower hose 1250mm with integrated anti-twist protection
- 1/2" connection
- Pipe diameter 20 mm

This article does not include a hand shower!

Intrinsic protection against back flow.

	Brushed Platinum	ST 050 304 5360-06 0010
	Chrome	ST 050 304 5360-00 0010
	Platinum	ST 050 304 5360-08 0010
	Durabrace (23kt Gold)	ST 050 304 5360-09 0010
	Brushed Durabrace (23kt Gold)	ST 050 304 5360-28 0010
	Brushed Dark Platinum	ST 050 304 5360-99 0010

Individual components of this set

You need the following components for this set



1x 11 420 360-06



1x 34 459 360-06 0010









MADISON Showerpipe with shower thermostat - Brushed Platinum

MADISON

ST 050 304 5360

ST 050 304 5360



	Brushed Platinum	11 420 360-06
	Chrome	11 420 360-00
	Platinum	11 420 360-08
	Durabress (23kt Gold)	11 420 360-09
	Brushed Durabress (23kt Gold)	11 420 360-28
	Brushed Dark Platinum	11 420 360-99



MADISON Showerpipe with shower thermostat - Brushed Platinum

MADISON

ST 050 304 5360



MADISON Showerpipe with shower thermostat - Brushed Platinum

MADISON

ST 050 304 5360

ST 050 304 5360



ST 050 304 5360

Parts for other finishes can be found here: [Chrome](#)



Spare parts list

No.	Item Number	Name	Quantity used	Delivery time
1	09 20 36 005-06	handle	1	10
2	09 26 01 016 90	accessories	1	2
3	09 20 83 006 90	handle	1	2
4	09 24 03 119 90	nipple	1	2
6	09 20 36 004-06	handle	4	10
7	90 30 30 027 00 90	screw	1	2
8	09 30 33 004 90	screw	1	2
10	90 21 33 020 00 90	handle	1	2

ST 050 304 5360



- shower with fixed riser projection 420mm
- overhead shower: rain flow
- rain shower Ø 200 mm
- rain shower with anti-scale system
- max. rainshower flow 6.8 l/min
- rotary diverter for fixed-riser shower/hand shower
- height of fittings up to rain shower (bottom edge) 985mm
- height of fittings up to top edge of elbow 1160mm
- two-part push-on rosette Ø 65 mm
- rosette for shower holder Ø 65mm
- rosette for wall mounting Ø 60mm
- gauge 150 mm - 13 mm
- metal shower hose 1250mm with integrated anti-twist protection
- 1/2" connection
- Pipe diameter 20 mm







- This product reduces water consumption by % (compared to requirements of EPAct '92)
- This product can contribute to Water Use Reduction in LEED® Green Building Rating

Intrinsic protection against back flow.

NOTE: Hand shower sold separately. Please see hand shower options under the miscellaneous articles section of each series.

Intrinsic protection against back flow.

NOTE: Hand shower sold separately. Please see hand shower options under the miscellaneous articles section of each series.

	Brushed Platinum	34 459 360-06 0010
	Chrome	34 459 360-00 0010
	Platinum	34 459 360-08 0010
	Durabrand (23kt Gold)	34 459 360-09 0010
	Brushed Durabrand (23kt Gold)	34 459 360-28 0010
	Brushed Dark Platinum	34 459 360-99 0010

Required miscellaneous



Concealed adapter - 35 080 970-90
 •please order two adapters (USA only) 0010



MADISON Showerpipe with shower thermostat - Brushed Platinum

MADISON

ST 050 304 5360

ST 050 304 5360

1:10

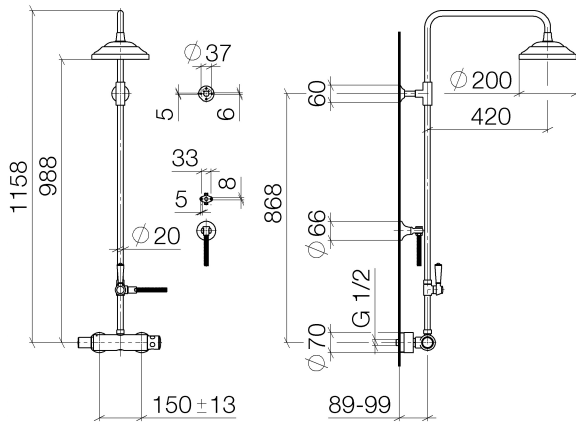

Flow rate chart

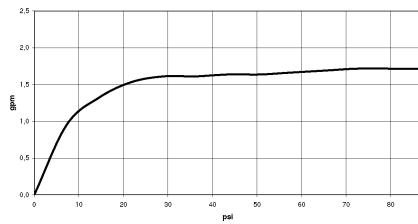

Codes & Standards

ASME A112.18.1/CSA B125.1	California Energy Commission (CEC)
---------------------------------	--

ST 050 304 5360

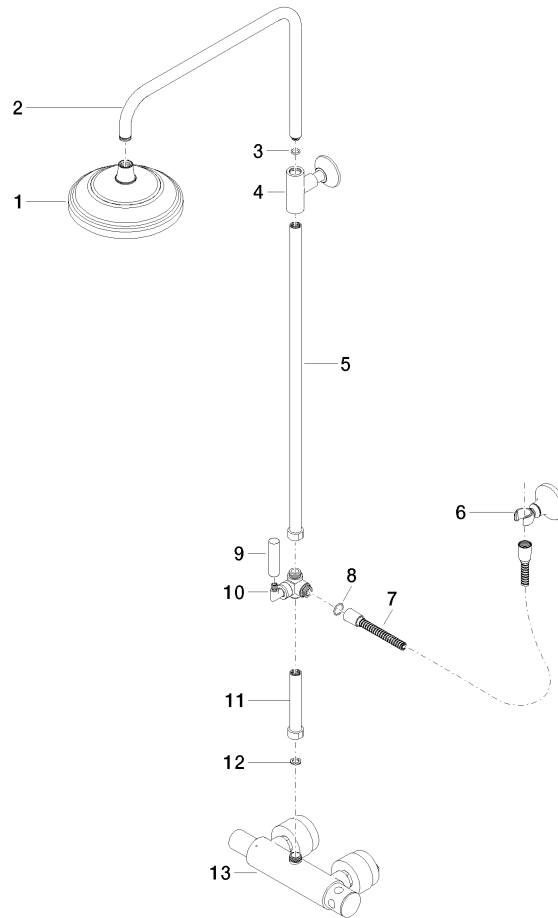

Spare parts list

No.	Item Number	Name	Quantity used	Delivery time
1	04 12 05 038 30-06	shower	1	10
2	04 28 22 101 20-06	spout	1	10
3	90 14 10 011 00 90	seal	1	2
4	90 17 11 037 01-06	holder	1	-
Spare part can no longer be ordered, please order the replacement item				
5	90 28 22 104 00-06	pipe	1	-
Spare part can no longer be ordered, please order the replacement item				
6	90 17 09 045 01-06	diverter	1	10
7	09 30 30 064-06	screw	1	10
8	09 18 20 011-06	base	1	10
9	09 28 22 013 90	pipe	1	2
10	11 170 370-06	MADISON Lever insert - Brushed Platinum	1	10
11	09 30 30 062-06	screw	1	10
12	09 14 10 122 90	seal	1	2
13	28 104 970-06	Metal shower hose 1/2" x 1/2" x 1250 mm - Brushed Platinum	1	2
14	28 050 410-06	holder	1	60
15	90 28 22 103 00-06	pipe	1	-
Spare part can no longer be ordered, please order the replacement item				
16	90 14 20 002 00 90	seal	1	2
17	04 17 01 044 01-06	fitting	1	10